

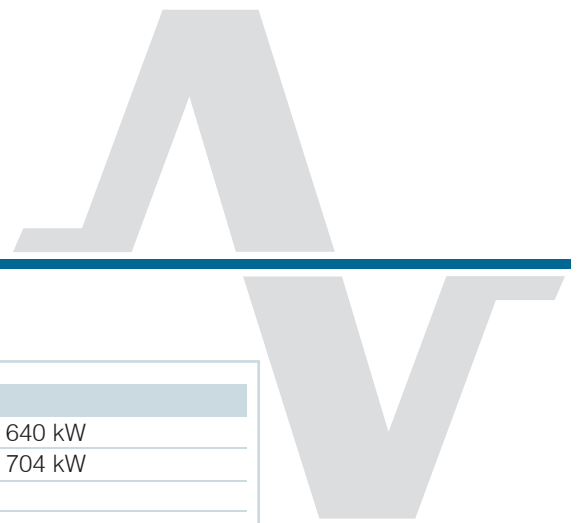

AUSONIA

OUR ENERGY, YOUR POWER



TECHNICAL DATA

BA0800SWD

GENSET SPECIFICATIONS

Prime Power (PRP)	800 kVA	640 kW
Stand-by (LTP)	880 kVA	704 kW
Power factor (cosphi)	0,8	
Voltage	400/230 V	
Frequency	50 Hz	

ENGINE SPECIFICATIONS

Brand	BAUDOUIN
Type	12M26G900/5
Net engine power prime	693,4 kW
Net engine power stand-by	761,4 kW
Aspiration	TCA
Cycle	diesel 4 stroke
Cooling	water
Speed	1500 r.p.m.
Cylinders	12 V
Bore x stroke	150 x 150 mm
Displacement	31,800 l
Fuel consumption 75% prime power	125 l/h +/- 5%
Oil consumption	0,3% of fuel consumption
Oil sump capacity	114 l
Coolant system capacity (engine & radiator)	191 l
Standard voltage	24 V
Governor type	electronic

ALTERNATOR SPECIFICATIONS

Power (PRP)	800 kVA
Overload	10% for 1 hour
Voltage	400/230 V
Frequency	50 Hz
Speed	1500 r.p.m.
Temperature rise	H
Insulation class	H
Degree of protection	IP 23

STANDARD EQUIPMENT

Starting motor and alternator battery charger
Dry air filter with removable element
Radiator mounted on skidbase
Water preheating system
Protection for fan and moving parts
Exhaust gas silencer
Built-in fuel tank 120 l
First filling oil
Skidbase with antivibrating shock-absorbers
Lead type batteries with cables and tray
Lifting devices
4-pole circuit breaker in fixed configuration, manual control

Rating according ISO 8528

Prime Power (PRP)

It is defined as being the maximum power which a generating set is capable of delivering continuously whilst supplying a variable electrical load when operated for an unlimited number of hours per year under the agreed operating conditions with the maintenance intervals and procedures being carried out as prescribed by the manufacturer. The permissible average power output over 24 h of operation shall not exceed 70% of the prime power. A 10% overload capacity is available for a period of 1 hour within a 12-hour period of operation.

Limited-Time Running Power (LTP)

It is defined as the maximum power available, under the agreed operating conditions, for which the generating set is capable of delivering for up to 500 h of operation per year (of which no more than 300 for continuative use) with the maintenance intervals and procedures being carried out as prescribed by the manufacturers. No overload capability is available.





AUSONIA

OUR ENERGY, YOUR POWER



TECHNICAL DATA

BA0800SWD

CONTROL PANEL

- Genset control with automatic management of load transfer DG/Mains
- Controller with thresholds, counters, alarm, status
- LCD display with pushbutton access for monitoring electrical and mechanical parameters
- Advanced programmable I/O functions
- Multilanguages text for measurements setting and messages
- Remote communication interface
- List of events
- Static battery charger

SOUNDPROOFED CANOPY

- Highly corrosionproof
- Electrogalvanized steel structure with modular components
- Antianimal protection grid (air intake)
- Exhaust silencer with rain flap
- Doors with yale type key
- Emergency stop
- Fast cables connections
- Easy access to the genset for maintenance

AVAILABLE OPTIONS

- Different soundproofing levels for canopied gensets
- Solutions for arctic or hot environment
- A wide selection of genset controllers and synch panels
- Additional alarms (warning / shutdown)
- Extended fuel tank capacity
- Automatic refuelling kit
- Automatic transfer switch panel (ATS)
- Residential Silencer (for open set only)
- Leak proof tray
- Special tools

DIMENSIONS AND WEIGHTS

Open set on skid base	LxWxH: mm tbd	Dry: kg tbd
Soundproofed canopy Silent version (*)	LxWxH: mm 6000x2180x2400	Dry: kg 8700

(*) Dimensions don't include residential exhaust muffler because this item is supplied loose to be mounted on the canopy roof

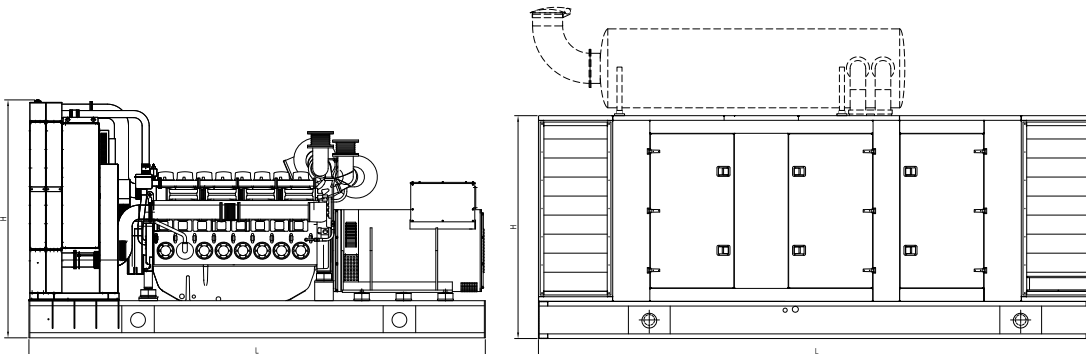

For further information on our standard and optional features, please contact our sales office at: sales@ausonia.net